

CORRECTION DES DIMENSIONS

AJUSTEMENT DE LA VERRIÈRE

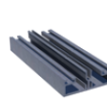

Ex: $100 - 10 = 90$

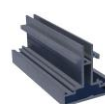
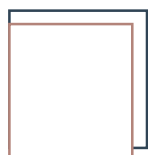
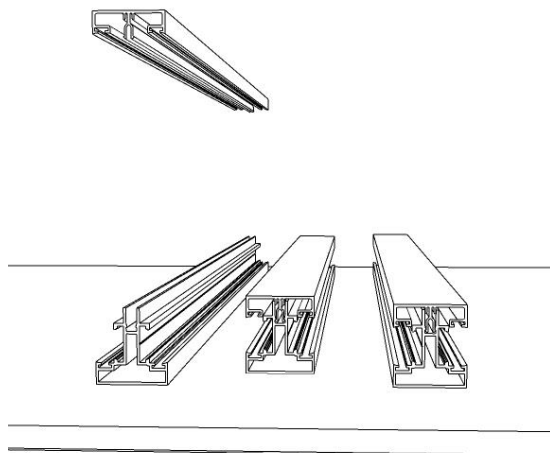
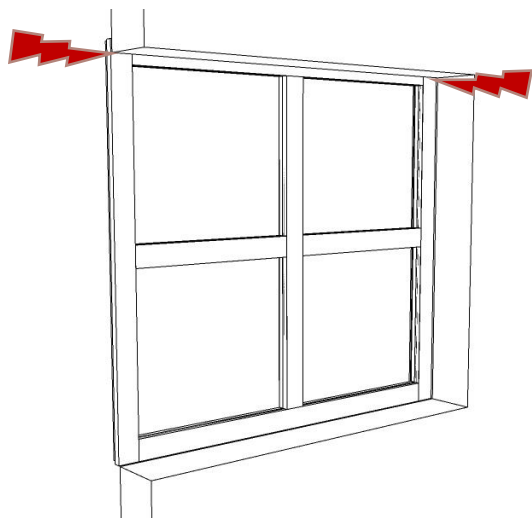

-10

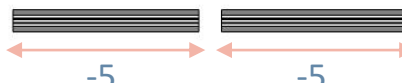

-5

-5

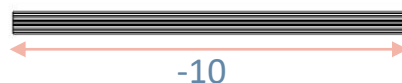

-10

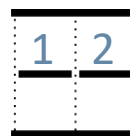

$\div 2$